

1 2 3 4 5 6 7 8

版次 (Version)	变更内容 (Rev. Content)	变更者 (Change Person)

A

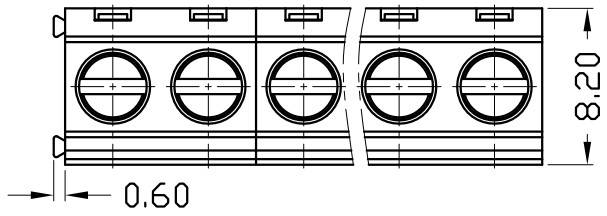

B

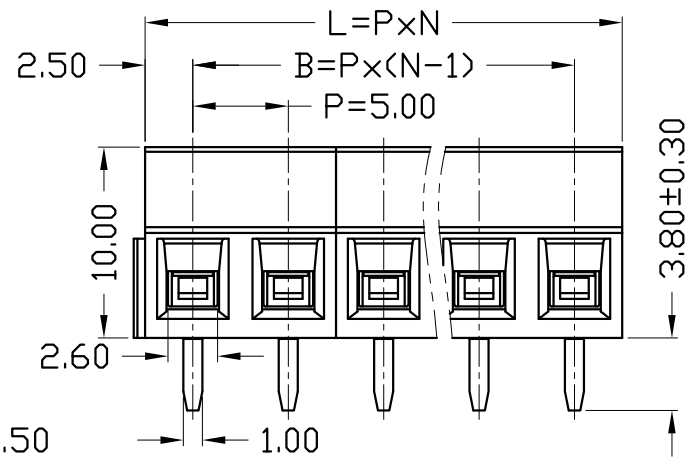

C

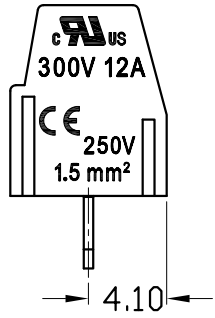

D

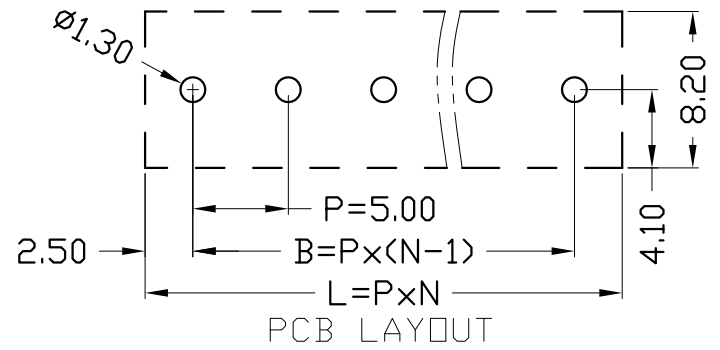

E

P=5.0mm, N为孔位数 (N for hole digits), 有效位数为 (Significant Digits): 02P~XXP

N	02P	03P	04P	05P	06P	07P	08P	09P	10P	11P	12P	13P
L	10.00	15.00	20.00	25.00	30.00	35.00	40.00	45.00	50.00	55.00	60.00	65.00
B	5.00	10.00	15.00	20.00	25.00	30.00	35.00	40.00	45.00	50.00	55.00	60.00
N	14P	15P	16P	17P	18P	19P	20P	21P	22P	23P	24P	...
L	70.00	75.00	80.00	85.00	90.00	95.00	100.00	105.00	110.00	115.00	120.00	
B	65.00	70.00	75.00	80.00	85.00	90.00	95.00	100.00	105.00	110.00	115.00	

技术参数 (Technical Data)

项目 (Item)	UL	IEC
额定电气参数 (Rated Electrical Parameters)	300V/12A	250V/15A
压线范围 (Wire Range)	26~14AWG	1.5mm ²
工频耐压 (Frequency Voltage)	AC 2000V	
冲击耐压 (Rated Surge Voltage)	4000V	
绝缘阻抗 (Insulation Resistance)	DC500V 500MΩ above	
接触电阻 (Contact Resistance)	≤8mΩ	
剥线长度 (Stripping Length)	6mm	
工作温度 (Temperature)	-40°C~+105°C	

材质和电镀 (Material and plating)

绝缘材质 (Housing)	PA66 (UL94 V-0)
触点材料 (Contact)	铜合金, 镀锡 (Copper alloy, Sn plated)
螺丝 (Screws)	钢, 镀锌 (Steel, Zn plated)
方盒 (Cage)	铜合金, 镀镍 (Copper alloy, Ni plated)

产品命名编码:

(Product Number Code):

GS009S-5.0-XXP-1Y-00A (H)

产品型号 (Series No.)

客户需求

(Customer Request)

极数 (No. of poles)

塑体颜色 (Housing Color)

- 1: 单倍间距 (Single Pitch)
- 2: 双倍间距 (Double Pitch)

- 1: 绿色 (Green)
- 2: 蓝色 (Blue)
- 3: 黑色 (Black)
- 4: 灰色 (Grey)
- 5: 橙色 (Orange)
- 6: 红色 (Red)
- 7: 透明色 (Transparent)
- 8: 白色 (White)
- 9: 黄色 (Yellow)
- Y: 多种颜色 (Mixed Color)

GOOSVN 宁波高胜电子有限公司
NINGBO GOOSVN ELECTRONIC CO.,LTD

公差范围 (Tolerance Range)

150~	±1.50
60~150	±1.00

型号 (Type): GS009S-5.0-XXP-1Y-00A (H)

30~60	±0.60
6~30	±0.40
0~6	±0.25

核准 (Approval):

图号 (Drawing NO.):

审核 (Audit):

单位 (Units): mm 页码 (Page): 1/1

设计 (Design):

比例 (Scale): FULL

角度 (Angle)	X	±2°
	XX	±1°

版次 (Version): T0

1 2 3 4 5 6 7 8

1 2 3 4 5 6 7 8

版次 (Version)	变更内容 (Rev. Content)	变更者 (Change Person)

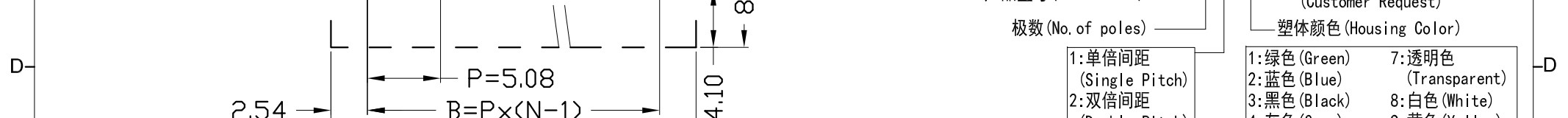
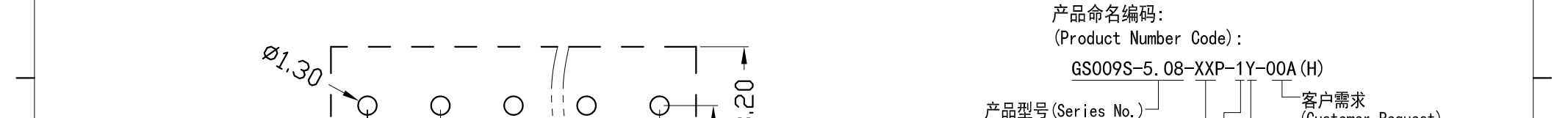
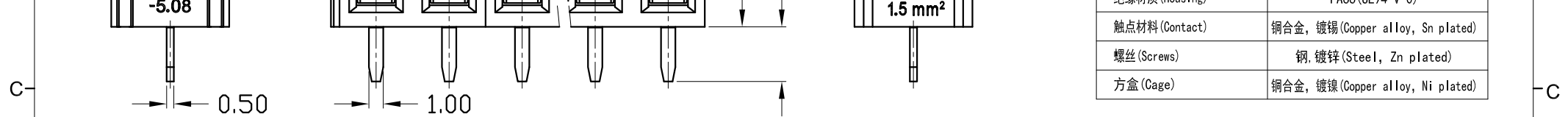
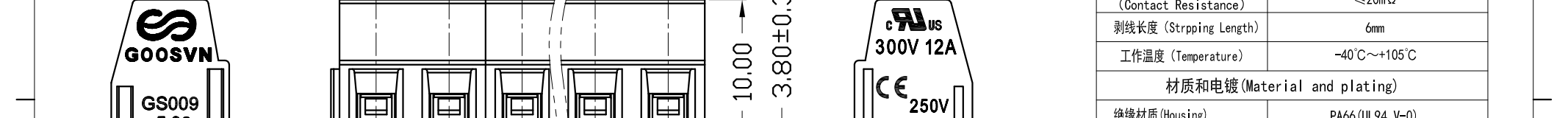
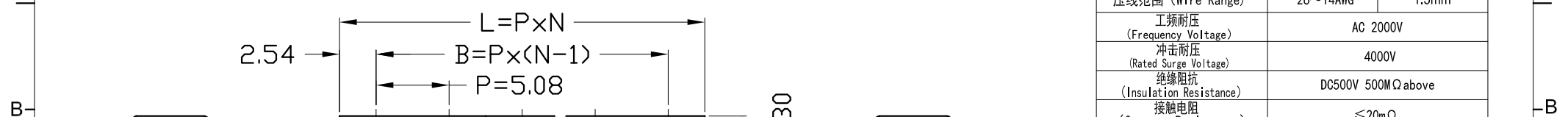
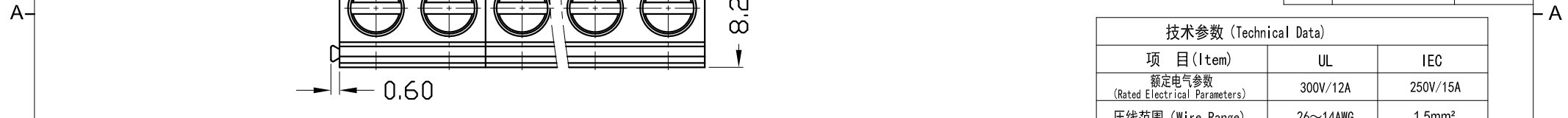

P=5.08mm, N为孔位数 (N for hole digits), 有效位数为 (Significant Digits): 02P~XXP												
N	02P	03P	04P	05P	06P	07P	08P	09P	10P	11P	12P	13P
L	10.16	15.24	20.32	25.40	30.48	35.56	40.64	45.72	50.80	55.88	60.96	66.04
B	5.08	10.16	15.24	20.32	25.40	30.48	35.56	40.64	45.72	50.80	55.88	60.96
N	14P	15P	16P	17P	18P	19P	20P	21P	22P	23P	24P	...
L	71.12	76.20	81.28	86.36	91.44	96.52	101.60	106.68	111.76	116.84	121.92	
B	66.04	71.12	76.20	81.28	86.36	91.44	96.52	101.60	106.68	111.76	116.84	

技术参数 (Technical Data)		
项目 (Item)	UL	IEC
额定电气参数 (Rated Electrical Parameters)	300V/12A	250V/15A
压线范围 (Wire Range)	26~14AWG	1.5mm ²
工频耐压 (Frequency Voltage)	AC 2000V	
冲击耐压 (Rated Surge Voltage)	4000V	
绝缘阻抗 (Insulation Resistance)	DC500V 500MΩ above	
接触电阻 (Contact Resistance)	≤20mΩ	
剥线长度 (Stripping Length)	6mm	
工作温度 (Temperature)	-40°C~+105°C	
材质和电镀 (Material and plating)		
绝缘材质 (Housing)	PA66 (UL94 V-0)	
触点材料 (Contact)	铜合金, 镀锡 (Copper alloy, Sn plated)	
螺丝 (Screws)	钢, 镀锌 (Steel, Zn plated)	
方盒 (Cage)	铜合金, 镀镍 (Copper alloy, Ni plated)	

产品命名编码:

(Product Number Code):

GS009S-5.08-XXP-1Y-00A (H)

产品型号 (Series No.)

客户需求
(Customer Request)

极数 (No. of poles)

塑体颜色 (Housing Color)

- 1: 单倍间距 (Single Pitch)
- 2: 双倍间距 (Double Pitch)

- 1: 绿色 (Green)
- 2: 蓝色 (Blue)
- 3: 黑色 (Black)
- 4: 灰色 (Grey)
- 5: 橙色 (Orange)
- 6: 红色 (Red)
- 7: 透明色 (Transparent)
- 8: 白色 (White)
- 9: 黄色 (Yellow)
- Y: 多种颜色 (Mixed Color)

宁波高胜电子有限公司 NINGBO GOOSVN ELECTRONIC CO.,LTD		公差范围 (Tolerance Range)
型号 (Type): GS009S-5.08-XXP-1Y-00A (H)		150~ ±1.50
核准 (Approval):		60~150 ±1.00
图号 (Drawing NO.):		30~60 ±0.60
审核 (Audit):		6~30 ±0.40
单位 (Units): mm		0~6 ±0.25
页码 (Page): 1/1		角度 (Angle) X ±2°
设计 (Design):		XX ±1°
比例 (Scale): FULL		版次 (Version): T0

1 2 3 4 5 6 7 8